

23/25-24

Canon

SURESHOT
Z90w

SURESHOT
Z90w
Caption

**PRIMA
SUPER 90**
WIDE

**PRIMA
SUPER 90**
WIDE
CAPTION

E

F

I

S

P



E Instructions

G Bedienungsanleitung

S Instrucciones

F Mode d'emploi

I Istruzioni

P Instruções

Handling Precautions

1. This camera is not resistant to water, and should not be used outdoors if it is raining or snowing. If it is accidentally dropped in water, contact an authorized Canon service facility. Keep the camera out of salt spray and excessive humidity. If used at the beach, clean it thoroughly afterward with a dry cloth.
2. Store the camera in a cool, dry, dust-free place. Be sure to keep the camera out of direct sunlight, and away from "hot spots" such as the trunk or rear window shelf of a car. Avoid places where mothballs are used, and use a desiccant in excessive humidity.
3. Do not attempt to disassemble the camera yourself, since there is high-voltage circuitry inside.
4. The battery may explode or cause burns if disassembled, recharged, shorted, exposed to high temperatures, or disposed of in a fire.
5. Use a blower brush to remove dust and sand from the lens and inside the camera. Do not apply any fluids to the lens or body. Take the camera to an authorized Canon service facility for a more thorough cleaning if necessary.
6. Film passing through X-ray examinations at an airport may be exposed and ruined even when loaded in the camera. Request a different method of inspection to avoid damage.
7. Color reproduction may be adversely affected if the film is left in the camera for a long time. Always develop exposed film promptly.

Convention

The following convention is used in these instructions:



Warnings you should observe when using the camera.



Additional information on using the camera.

(→ ■) is shorthand for "See page ■".

This device complies with Part 15 of the FCC Rules. Operation is subject to the following two conditions: (1) This device may not cause harmful interference, and (2) this device must accept any interference received, including interference that may cause undesired operation.

Do not make any changes or modifications to the equipment unless otherwise specified in the instructions. If such changes or modifications should be made, you could be required to stop operation of the equipment.

This equipment has been tested and found to comply with the limits for a class B digital device, pursuant to part 15 of the FCC Rules. These limits are designed to provide reasonable protection against harmful interference in a residential installation. This equipment generates, uses and can radiate radio frequency energy and, if not installed and used in accordance with the instructions, may cause harmful interference to radio communications.

However, there is no guarantee that interference will not occur in a particular installation. If this equipment does cause harmful interference to radio or television reception, which can be determined by turning the equipment off and on, the user is encouraged to try to correct the interference by one or more of the following measures:

- Reorient or relocate the receiving antenna.
- Increase the separation between the equipment and receiver.
- Consult the dealer or an experienced radio/TV technician for help.

1

This digital apparatus does not exceed the Class B limits for radio noise emissions from digital apparatus as set out in the interference-causing equipment standard entitled "Digital Apparatus", ICES-003 of the Industry Canada.

Cet appareil numérique respecte les limites de bruits radioélectriques applicables aux appareils numériques de Classe B prescrites dans la norme sur le matériel brouilleur: "Appareils Numériques", NMB-003 édictée par l'Industrie Canada.



The **CE** Mark is a Directive conformity mark of the European Community (EC)

Thank you for purchasing this Canon product.

Before taking pictures, please read these instructions carefully for a thorough understanding of how the camera operates.

Table of Contents

These instructions are divided into five sections: Introduction, Basic Operations, Active Operations, Advanced Operations, and Additional Information. When first using the camera, be sure to read the instructions from the Introduction.

1	Introduction	
	Handling Precautions	2
	Table of Contents	4
	Quick Reference	6
	Nomenclature	8
	Attaching and Using the Strap	12
	About the Eyesight Adjustment Knob	12
2	Basic Operations	
	1 Loading the Battery	13
	2 Loading the Film	14
	3 Turning the Power On	16
	4 Checking the Battery Power	17
	5 Holding the Camera	18
	6 Using the Zoom	19
	7 AUTO Taking Pictures in Auto Flash Mode.....	20
	AiAF (Smart AF) Function	21
	Green/Orange Indicators	22
	Taking Pictures through a Window	22
	Close-up Photography	23
	8 Removing the Film	24
3	Active Operations	
	☑ Shooting Against Dark Backgrounds	25
	Using Red-eye Reduction Function Effectively	26
	👤 Shooting Portraits.....	28
	🌸 Shooting Close-up	29

RT Shooting in Real Time.....	30
SPOT Shooting Very Bright or Very Dark Subjects	31

4 Advanced Operations

MODE Setting the Function.....	32
⚡ Changing the Flash Mode.....	34
(⚡) Auto Flash (No Red-eye Reduction)...	36
(⚡) Auto Flash with Red-eye Reduction...	37
⚡ Flash ON (Forced Flash)	37
(⚡) Flash OFF (Suppressed Flash)	38
(⚡) +1.5 (⚡) -1.5 Flash OFF with Manual Exposure Compensation....	39
(⚡) Slow-synchro	40
[] Using Single-Point Central Focusing	41
Using Focus Lock	42
<small>PERSONAL</small> Shooting with Customized Mode Functions ...	43
(⌚) Using the Self-timer	44
[] Remote Control Photography (CAPTION)	45
Replacing the Remote Control Battery ...	46
Imprinting the Date and Time (CAPTION)	47
Setting the Date and Time (CAPTION)	48
Imprinting Captions (CAPTION)	50

5 Additional Information

Troubleshooting	53
Questions and Answers	55
Specifications	56

Please note that these instructions are for both the model with the caption function and model without caption function. Information relevant only to the model with the caption function is marked with the **(CAPTION)** symbol.

The separately sold Remote Control RC-5 is available for use with the **(CAPTION)** model only.

Quick Reference

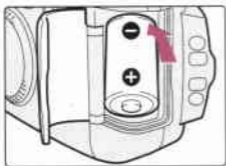

- 1** Load the battery. (→ 13)

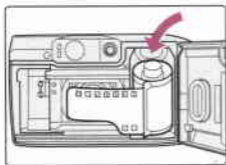

- 2** Load the film. (→ 14)

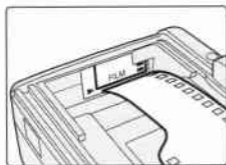

- 3** Pull the film tip across until it reaches the  mark. Then close the back cover. (→ 14)

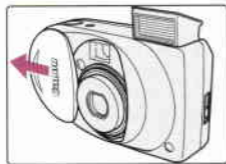

- 4** Slide open the lens cover. (→ 16)
- Slide the cover open until you hear a clicking sound.
 - ➔ The power comes on and the lens and flash are set.

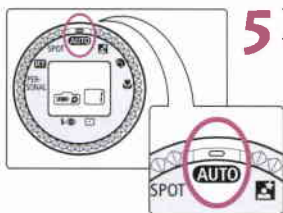

5 Turn the best shot dial to **AUTO**. (→ 20)

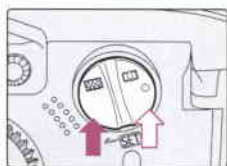

6 Use the **M** or **L** button to select the size of your subject. (→ 19)

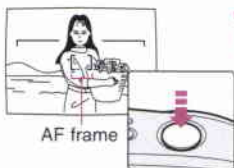

7 Position the AF frame over the subject and take the picture. (→ 20)

➔ In low-light, the flash fires automatically.

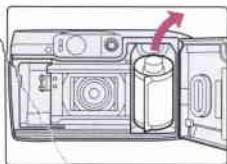

8 When you have finished the film and it has rewound, remove the film. (→ 24)

- Check that **Ⓢ** is flashing on the LCD panel and that the frame counter has returned to "0", and then open the back cover.
- Remove the film and close the back cover.

Nomenclature

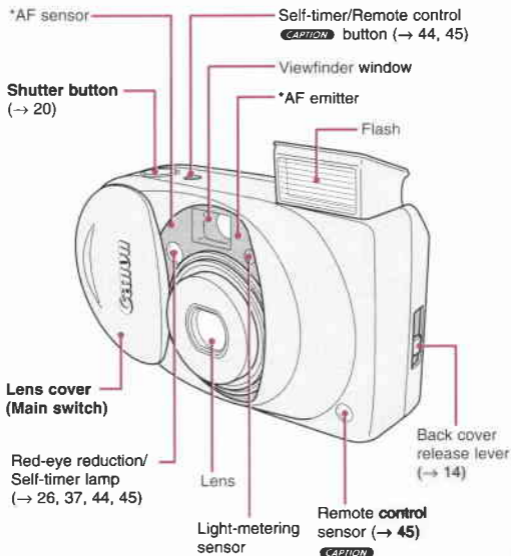

For further details, refer to the page indicated.

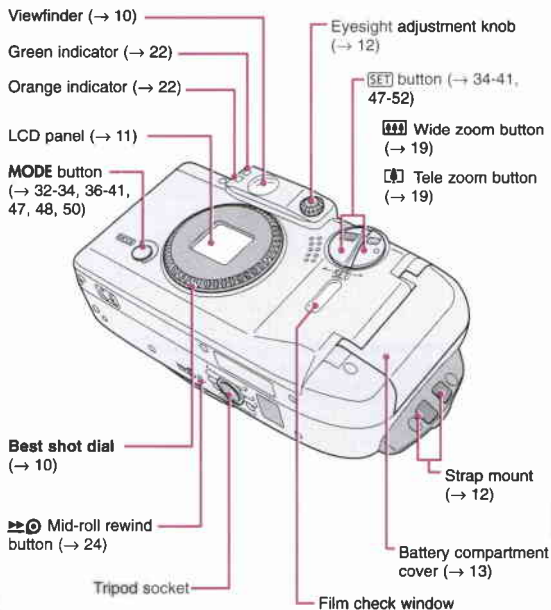

1

* AF is an abbreviation for Auto Focus.

Viewfinder Frames

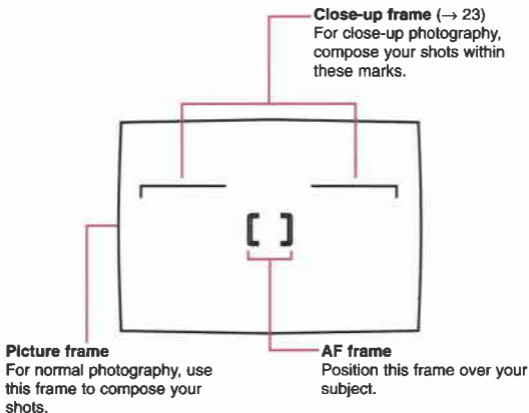

Best Shot Dial

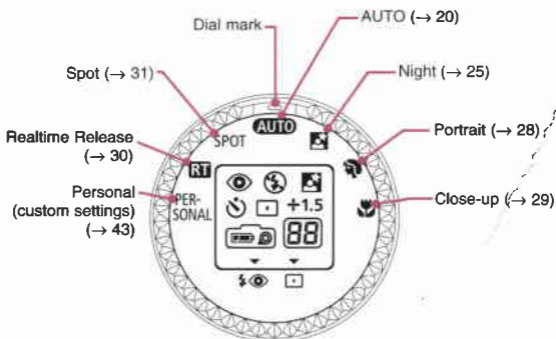

LCD Panel

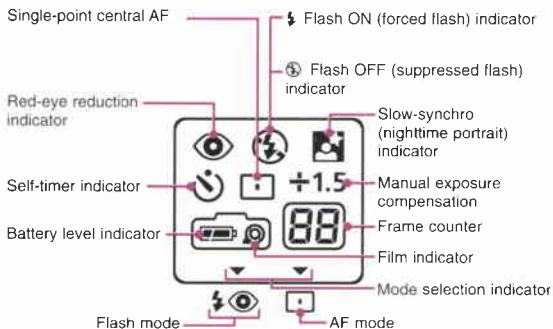
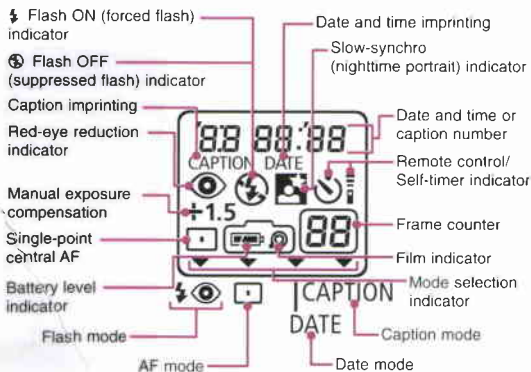
**CAPTION**

1

(Normally, only the required information is displayed.)

Attaching and Using the Strap

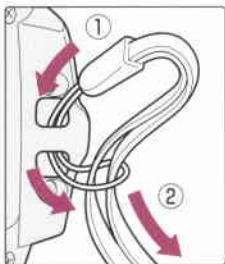

Attaching the strap.

- To ensure that you do not drop your camera, attach the strap provided.
- Attach the strap as shown in steps ① and ②.

About the Projections on the Strap Buckle

Move along the strap.

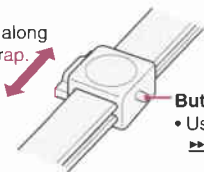

Button push projection

- Use this projection to press the  button. (→ 24)

About the Eyesight Adjustment Knob

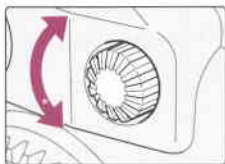

Turn the eyesight adjustment knob until you can see the image in the viewfinder clearly.

1 Loading the Battery

Applicable Battery: One lithium battery
(CR123A/DL123A)

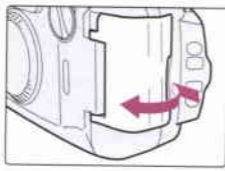

- 1 Open the battery cover.**
- To open, insert a coin into the slot.

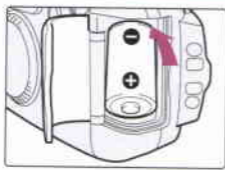

- 2 Load the new battery.**
- Align the + – terminals correctly and insert the battery – end first.
 - ➔ The  appears on the LCD panel.

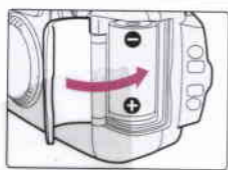

- 3 Close the battery cover.**
- Push the cover closed until you hear a clicking sound.
 - ➔ The date display on the LCD panel changes to "-- -- --". Set the date and time. (→ 48) **CAPTION**

1

2

2 Loading the Film

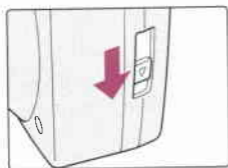

- 1** Open the back cover.
- Push the lever down.

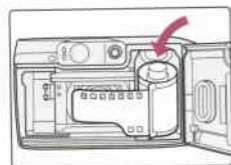

- 2** Load the film.

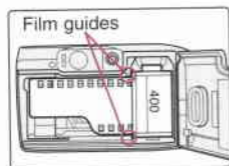

- 3** Position the film correctly between the film guides.

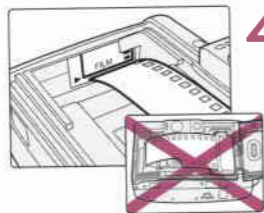

- 4** Pull the film out to the  (film leader position indicator).
- Make sure that there is no slack in the film when you pull it out.

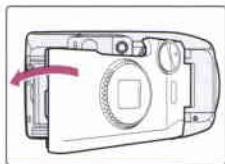

- 5 Close the back cover.**
- The film will automatically advance to the first picture on the roll.

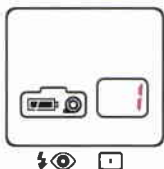

- 6 "1" is displayed in the frame counter.**
- If the frame counter shows a blinking "0", the film did not load correctly. Load the film again.



- Use only film that carries the DX mark. The camera will automatically detect and set the film speed.
- A film speed of ISO 400 is recommended.

3 Turning the Power On

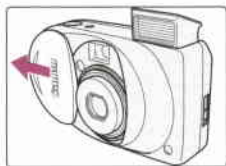

Slide open the lens cover.

- Slide the cover open until you hear a clicking sound.
- ➔ The lens and the flash is set.
- ➔ The lens is initially set to the wide-angle position.
- When you close the lens cover, the lens and flash retract and the camera turns off.



- Do not press on the lens or the flash.
- Pushing the flash unit in when you take a picture sets the flash mode to OFF. Take care not to inadvertently push the flash in.
- If the lens is not set for shooting, check to see if the battery is loaded correctly. (→ 13)





When you switch the camera off, the display on the LCD panel does not disappear.

4 Checking the Battery Power

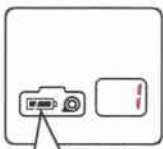
Check that the  icon appears on the LCD panel when you switch the camera on.



-  (on) The battery is fully charged.
-  (on) Prepare new battery.
-  (blinking) Fit the new battery. (→ 13)

A new battery will generally provide enough charge to shoot approx. 14 rolls of 24-exposure film (based on Canon's Standard Test Method at normal temperatures and with 50% flash use). At low temperatures (-10°C/14°F), the battery life is approximately one third of the normal figure.



- **If you are** travelling or plan to take a lot of pictures, take a supply of spare batteries. The correct batteries may be difficult to obtain at your destination.
- When you take consecutive shots using the flash, the battery power may drop off temporarily and prevent the LCD panel from displaying information correctly. If this occurs, switch the camera off and wait a few minutes before switching it back on again.

5 Holding the Camera

To ensure a clear sharp picture, hold the camera firmly so that it does not move when you take a picture.



- Hold the camera with both hands and brace your elbows lightly against your body.
- Rest the camera against your forehead, look through the viewfinder and then slowly and gently press the shutter button.



Light-metering sensor Flash

AF emitter

AF sensor

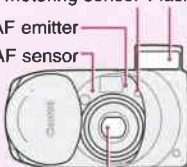

Lens

- When you hold the camera, take care to keep your hair, your fingers and the strap away from the lens, AF emitter/sensor, light-metering sensor and flash.
- Dust or soiling on the AF emitter/sensor causes focusing difficulties. Wipe soiled areas clean before taking pictures.
- Hold the camera still until you hear the sound of the film winding on, indicating that the camera has finished taking the picture.

6 Using the Zoom

You can use the  or  button to change the size of your subject.



 **Wide-angle**
(28 mm)

Use this setting for large-scale images such as scenery and group photos.



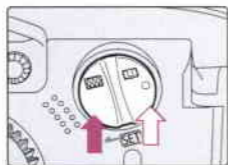

 **Telephoto**
(90 mm)

Use this setting for shots where you want to zoom in on your subject, such as portraits.



Press the  or  button.

- Pressing  zooms in on your subject while pressing  zooms out for a wide-angle shot.



Do not touch the lens while the lens is zooming.



- When you switch the camera on, the lens is initially set to the wide-angle (28 mm).
- If the lens is left extended in the telephoto position and is not used for 4 minutes, the lens is automatically retracted to wide-angle position.

7 **AUTO** Taking Pictures in Auto Flash Mode

In this mode, the AiAF function ensures that the subject stays in focus even when it is not exactly in the center of the viewfinder. The flash also fires automatically in low light or backlit conditions.

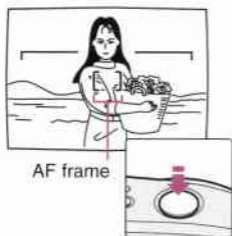

1 Set the focus.

- Position the AF frame over your subject and press the shutter button halfway.
- ➔ When the subject is in focus, the green indicator lights.
- When the flash fires automatically, the orange indicator lights and  appears on the LCD panel.
- Keep the shutter button pressed halfway down.

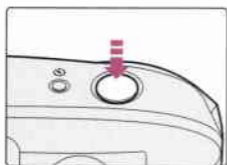

2 Compose the shot and take the picture.

- Press the shutter button down fully.
- Press the shutter button slowly and gently.
- ➔ The photograph is taken.



There is a very short delay between the shutter button being pressed and the shutter releasing. In general, you should continue to hold the camera still until you hear the sound of the film winding on, which indicates that the shot has been taken.



You can take a picture using the Realtime Release mode, in which the shutter is released instantly, if you set the dial to **RT**. (→ 30)

AiAF (Smart AF) Function

Ai = Artificial Intelligence, AF = Auto-focus

The AiAF (Smart AF) function has a wide measuring area and is the latest mechanism for accurate focus adjustment. This mechanism was developed based on the analysis of several thousand photographs and on Canon's unique expertise.



- The camera focuses on the subject even if it is not in the center of the viewfinder, or if there is an obstruction in front of it. The camera will also focus accurately on two subjects positioned side by side, and not on the background between them.





Green/Orange Indicators

When you press the shutter button down halfway, the indicators light or blink to show whether the camera is ready to shoot.

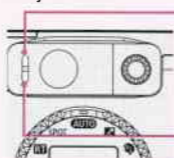

Green indicator

Lit: Camera ready to shoot (subject in focus).

Blinking: Proximity warning

Orange indicator

Lit: Flash fully charged.

Blinking: Camera shake warning (in  mode)



- When the proximity warning appears, move away from the subject until the indicator stops blinking and press the shutter button again.
- The green indicator may light even at distances of 30 cm/1 ft. Take care not to get too close to the subject.
- When the camera shake warning appears, use a tripod or other camera mount.
- **Taking Pictures through a Window**

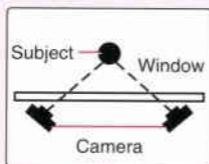

If you are taking a picture through a window, set the camera at an appropriate angle, with a camera-to-window distance of about 20 cm/0.7 ft.

If you are too far away from the window, the camera may focus on the glass of the window rather than the subject.

Close-up Photography

When you are shooting at distances of 1 m/3.3 ft. or less, the area visible through the viewfinder does not match the area actually included in the shot. The area above the close-up frame markings will not be included in the photograph. For pictures taken at distances of 1 m/3.3 ft. or less, follow the steps below, using the close-up frame.

Close-up frame markings indicating the areas not photographed

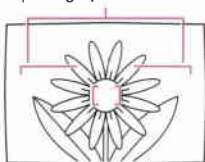

Area visible in the viewfinder that is not photographed

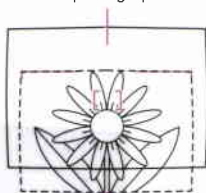

Area actually photographed (inside dotted line)

1 Set the focus.

- Position the AF frame over your subject and press the shutter button halfway.
- Check that the green indicator lights.
- Keep the shutter button pressed halfway down.

2 Compose the shot and take the picture.



- Compose the shot so that the subject is below the close-up frame and then take the picture.
- Do not change the distance from the camera to the subject.

8 Removing the Film

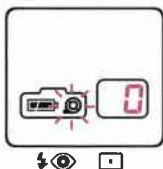
The film rewinds automatically when it reaches the end. The frame counter counts down as the film rewinds. When the film is fully rewound, the frame counter shows "0" and the  blinks.



1 Check that the frame counter shows "0".

- If the  is not blinking, press the  button.

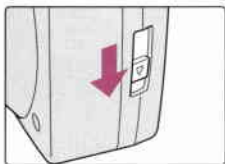

2 Open the back cover.

- Push the lever down and remove the film.

Rewinding the film in mid-roll

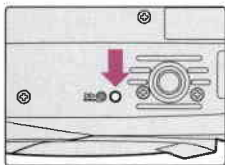

- Use the button push projection on the strap buckle (→ 12) to press the  button on the bottom of the camera.
- Hold the button down until the film starts to rewind.



If you shoot more than the stipulated number of exposures on a roll of film, the final shot may be lost during developing and processing, or the date and time may not be imprinted on the final shot.



Shooting Against Dark Backgrounds

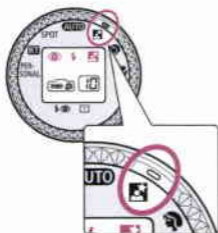

Use this mode when you are taking pictures of people against a sunset or nighttime background. The flash illuminates the subject and the slow shutter speed captures the background, allowing you to take beautiful pictures.

E

Turn the dial to .

- Follow the steps in **AUTO** (→ 20) to take a picture.



- Because the red-eye reduction function operates before the picture can be taken, there is a 1-second delay before the shutter releases. Keep the shutter button held down until you hear the sound of the film winding on.
- No camera shake warning is given. Because of the slow shutter speeds (up to 4 seconds), you must use a tripod to hold the camera steady. You should also ensure that the subject does not move in the moment after the flash fires.

2

- In some conditions, **AUTO** (→ 20) may give better results. For this reason, it is best to take the picture in both  and **AUTO** modes.
- You can also suppress the flash so that only the nighttime background is shot. (→ 38)
- You can also include yourself in the shot by using the self-timer or remote control **CAPTION**. (→ 44, 45)

3



Using Red-eye Reduction Function Effectively

When you use the flash to take photos of people in low light conditions, their eyes sometimes glow red in the photograph. This is referred to as the red-eye effect and is caused by the light of the flash being reflected off the retina of the eye.

When the red-eye reduction operates, the red-eye reduction lamp lights for approximately 1 second before the flash fires. This causes the subject's pupils to contract, minimizing the risk of red-eye.

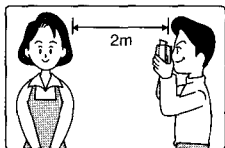

- ① Take the picture from within 2 m/6.6 ft. of your subject.

- The red-eye reduction lamp has an effective range of 2 m/6.6 ft.

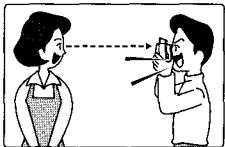

- ② Attract the subject's attention so that he or she looks at the camera.

- Red-eye reduction is not effective if the subject is not looking directly at the camera.

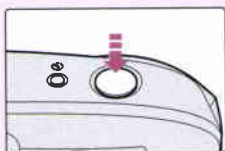

- ③ Take the picture.
- Slowly press the shutter button down fully.
 - ➔ Shutter release is delayed for about a second while the red-eye reduction lamp lights.
 - Keep the shutter button pressed down until you hear the sound of the film winding on.



- The effectiveness of the red-eye reduction function varies from person to person.
- Set the lens to the wide-angle position.
- Raise the ambient light level as much as possible.

Shooting Portraits



Use this mode when you want to lessen the impact of the background and highlight the subject. The camera automatically zooms in to frame the upper part of the subject's body and fires the flash for every shot to produce highlights in the subject's eyes.

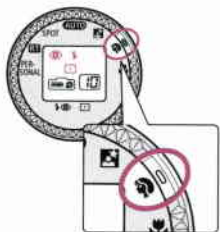

Turn the dial to .

- Position the AF frame over your subject and take the picture.



In order for the red-eye reduction function (→ 26) to operate, there is a 1-second delay before the picture can be taken. Keep the shutter button held down until you hear the sound of the film winding on.



In automatic zooming, the upper part of the subject's body is framed at distances of 0.7 to 2.1 m/2.3 to 6.9 ft. from the subject. You can also adjust the zoom setting after automatic zooming is finished. (→ 19)

Shooting Close-up

E

Use this mode when you want to take close-up pictures of flowers and insects.

The lens automatically locks into position at 90 mm and you can get as close to 45 cm/1.5 ft. to the subject to take a picture.

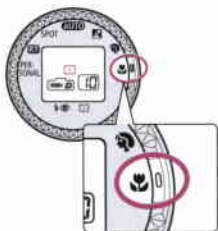

Turn the dial to .

- The lens automatically zooms to 90 mm and locks into position.
- Position the AF frame over your subject and take the picture.
- If you are shooting at less than 1 m/3.3 ft. from the subject, follow the instructions given in "Close-up Photography" (→ 23).



- **The lens automatically zooms to 90 mm and locks into position.** You cannot operate the zoom.
- **if the green indicator blinks,** move away from the subject until the indicator stops blinking. (→ 22)



In this mode, the shooting distance is between 0.45 m/ 1.5 ft. to ∞.

3

RT Shooting in Real Time



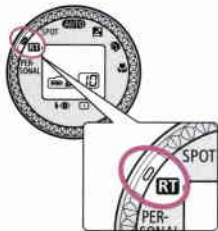

Use this mode when you want to take pictures in real time. Usually when you take pictures, there is a very short delay between the shutter button being pressed and the shutter releasing. In **RT** mode, press the shutter button down halfway to focus on the subject and then push the button down fully to take a picture in real time.



Turn the dial to **RT**.

- Position the AF frame over your subject and press the shutter button down halfway.
- ➔ There is a brief zooming sound as the camera focuses on the subject.
- Keep the shutter button pressed halfway down.
- When you are ready to take the picture, press the shutter button down fully.



- If you press the shutter button all the way down in a single movement, realtime release does not operate.
- Take care that the distance from the camera to the subject does not change. If the distance does change, start again from step 1.
- Take care not to touch the lens as this may result in the picture being out of focus.
- We do not recommend using red-eye reduction when the flash mode is set to  or , as you cannot take a picture immediately.



The focus lock function can be used in the same way as for normal photography. (→ 42)

SPOT Shooting Very Bright or Very Dark Subjects

E

Use this mode to take beautiful pictures of your subject in shots with strong contrast, such as a person illuminated by a spotlight or on a ski slope.

This mode allows you to set the focus and exposure for the center of the viewfinder.

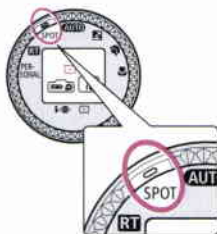

Turn the dial to SPOT .

- Position the AF frame over your subject and take the picture.

3

The automatic flash and exposure compensation normally used for backlit subjects are not used in this mode.

MODE Setting the Function

Use this button to set the flash mode (→ 34), AF mode (→ 41), date mode (→ 47) or caption mode (→ 50).

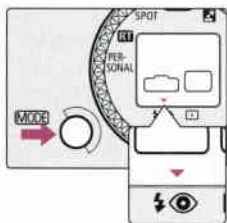

1 Select a mode.

- Press the **MODE** button.
- ➔ Each time the **MODE** button is pressed, ▼ appears above each mode in the following order.

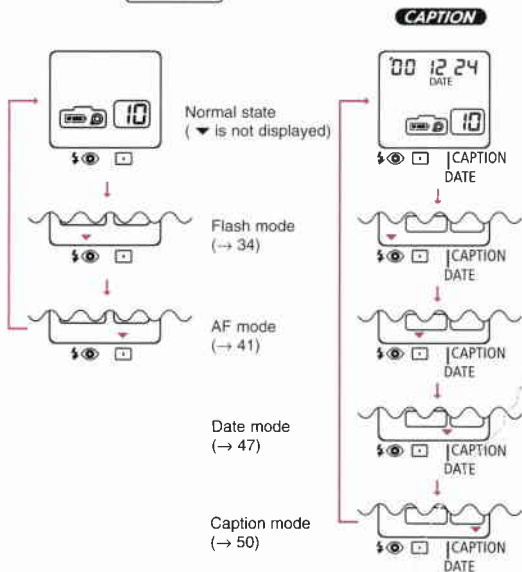

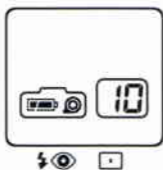

- 2 Complete the setting.**
- When you have completed the setting, press the **MODE** button. The camera returns to the normal state in which ▼ is not displayed.
 - Refer to the pages shown for information on how to set each mode.



If you do not **select** a setting for **10 seconds** when the camera is in **the** mode selection state (▼ is displayed), the camera will automatically revert to the normal state.

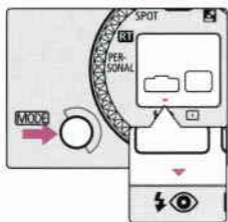

Changing the Flash Mode

You can cause the flash to fire for every shot or suppress flash operation completely to suit the subject or location.

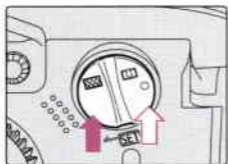

- 1 Select Flash mode.**
 - Press the **MODE** button until ▼ appears above .



- 2 Select the flash mode.**
 - The flash mode changes each time you press the **SET** ( or ) button.
 - When you have selected the desired flash mode, press the **MODE** button to return the camera to the normal state. (→ 33)



When you turn the best shot dial, the flash mode reverts to the mode designated for the selected mode function.

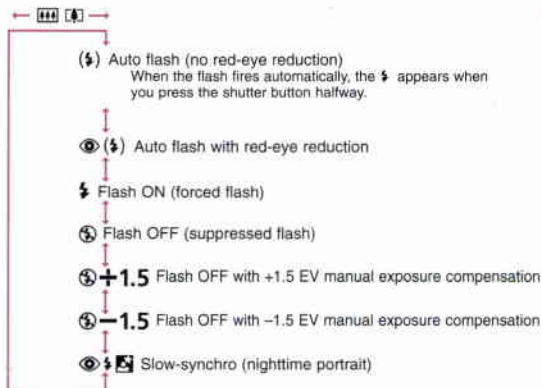

Effective Flash Range (using negative color film)

Film speed	Wide-angle	Telephoto
ISO 100	0.6 to 3.7 m (2 to 12.1 ft.)	0.6 to 2.3 m (2 to 7.5 ft.)
ISO 200	0.6 to 5.2 m (2 to 17.1 ft.)	0.6 to 3.3 m (2 to 10.8 ft.)
ISO 400	0.6 to 7.4 m (2 to 24.3 ft.)	0.6 to 4.6 m (2 to 15.1 ft.)



(⚡) Auto Flash (No Red-eye Reduction)

Use this mode to take pictures of subjects other than people, or to photograph people without using the red-eye reduction lamp so that the shutter releases immediately.

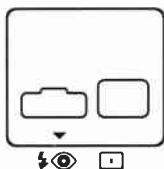
In low light or backlit conditions, the flash fires automatically when you press the shutter button.



Set (⚡) when the camera is in Flash mode. (→ 34)

- Press the **SET** () or () button until only ▼ is displayed.
- Press the **MODE** button to return the camera to the normal state. (→ 33)
- ➡ When the flash fires automatically, the orange indicator lights and ⚡ appears on the LCD panel when you press the shutter button down halfway.
- Take the picture.





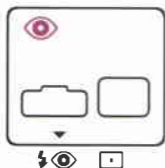

In **AUTO**, **SPOT** and **RT** modes, you can select whether the auto flash mode initially set when you switch the camera on is with or without red-eye reduction. Set the camera to the desired auto flash mode and then switch the camera OFF.

Auto Flash with Red-eye Reduction

Use this mode to reduce the red-eye effect (→ 26) when you are taking pictures of people in low light conditions. When you press the shutter button, the red-eye reduction lamp lights and then the flash fires.





Set  when the camera is in Flash mode. (→ 34)

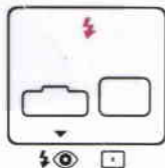

- Press the **SET** ( or ) button to display  on the LCD panel.
- Press the **MODE** button to return the camera to the normal state. (→ 33)
- Take the picture.

Flash ON (Forced Flash)

In this mode, the flash fires regardless of the light conditions when the picture is taken. Use this setting for fill-in flash in daylight or to soften the outline of your subject.



Set  when the camera is in Flash mode. (→ 34)

- Press the **SET** ( or ) button to display  on the LCD panel.
- Press the **MODE** button to return the camera to the normal state. (→ 33)
- Take the picture.



Flash OFF (Suppressed Flash)

In this mode, the flash does not fire regardless of how dark conditions are when the picture is taken.

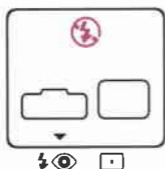

Use this mode for sunset shots, for places where flash use is prohibited, or for available-light photography.



Set  when the camera is in Flash mode. (→ 34)

- Press the **SET** ( or ) button to display  on the LCD panel.
- Press the **MODE** button to return the camera to the normal state. (→ 33)
- Take the picture.



- Because a slow shutter speed is used (up to 2 seconds) when the flash is set to , ,  (→ 39) in low light conditions, take care to avoid camera shake.
- When the orange indicator blinks (camera shake warning), use a tripod or other means to hold the camera steady.

⊕+1.5 / ⊖-1.5 Flash OFF with Manual Exposure Compensation

This camera is provided with an automatic exposure compensation function for backlit shots, but you can also use exposure compensation at any time.

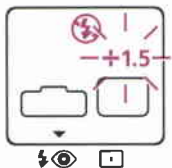

Set ⊕+1.5 or ⊖-1.5 when the camera is in Flash mode. (→ 34)

- Press the **SET** () or () button to display ⊕+1.5 or ⊖-1.5 on the LCD panel.
- ➔ Either ⊕+1.5 or ⊖-1.5 blinks on the LCD panel.
- Press the **MODE** button to return the camera to the normal state. (→ 33)
- Take the picture.

• ⊕+1.5 Exposure Compensation

You can use this setting to prevent your subject being too dark (underexposed) when the surroundings are extremely bright, such as at a ski-resort or in backlit conditions. You can also use this setting to brighten the entire picture.

• ⊖-1.5 Exposure Compensation

You can use this setting to prevent your subject being too bright (overexposed) when the surroundings are extremely dark, such as on a spotlight stage. You can also use this setting to darken the entire picture.





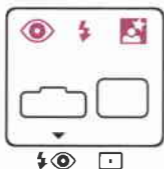

- Automatic exposure compensation is not performed in ⊕+1.5, ⊖-1.5.
- The flash does not fire in ⊕+1.5, ⊖-1.5.
- The effects of exposure compensation may be difficult to see on prints from negative color film.

Slow-synchro



This function is useful when you are taking pictures of people against a sunset or nighttime background. The combination of slow shutter speed and flash illuminates the subject while still capturing the background not reached by the flash.









Set    when the camera is in Flash mode. (→ 34)

- Press the **SET** ( or ) button to display    on the LCD panel.
- Press the **MODE** button to return the camera to the normal state. (→ 33)
- Take the picture.



Because a slow shutter speed (up to 2 seconds) is used in    , always use a tripod to prevent camera shake. Take care also to ensure that the subject does not move immediately after the flash fires.



- The red-eye reduction function operates in this mode.
- In some conditions,   mode (→ 37) may give better results. For this reason, it is best to take the picture in both    and   modes.

Using Single-Point Central Focusing

The **AUTO**, **[M]**, **RT** and **PERSONAL** modes use AiAF (3-point focusing), but you can also set the camera to single-point central AF **[□]** mode.

This mode is useful when you are photographing a subject that is at the edge of the frame (→ 42) or when you want to focus solely on your subject.

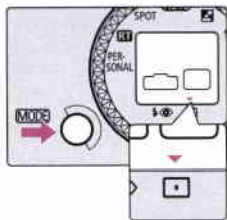

- 1** **Select the AF mode.**
- Press the **MODE** button until ▼ appears above **[□]**.



- 2** **Set single-point central AF **[□]** mode.**

- Press the **SET** (**[□]** or **[□]**) button.
- ➔ **[□]** appears on the LCD panel.
- If you press the **SET** (**[□]** or **[□]**) button again, **[□]** disappears from the LCD panel and AiAF (→ 21) is set.
- When you have selected the desired AF mode, press the **MODE** button to return the camera to the normal state. (→ 33)

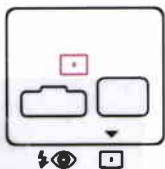

Using Focus Lock

Lock the focus when you want the subject of your shot to be off to one side of the frame.

While AiAF can be used for shots of this type, single-point central AF is recommended. (→ 41)

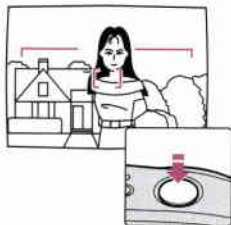

1 Set the focus.

- Position the AF frame over your subject and press the shutter button halfway.
- ➔ When the subject is in focus, the green indicator lights.
- Keep the shutter button pressed halfway down.

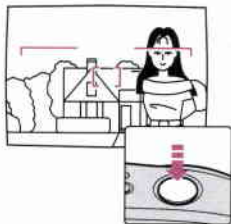

2 Compose the shot and take the picture.

- Compose the shot.
- Press the shutter button down fully.
- Press the button down slowly and gently.
- ➔ The photograph is taken.



Take care that the distance from the camera to the subject does not change. If the distance does change, lock the focus again.



When you are shooting in remote control **CAPTION** mode (→ 45), the focus remains locked for approximately 4 minutes after you lock the focus in step 1, even if you release the shutter button. This gives you time to set the focus beforehand, compose the shot, and then take the picture.

This mode allows you to combine flash modes and AF modes freely to set and store your own custom mode.

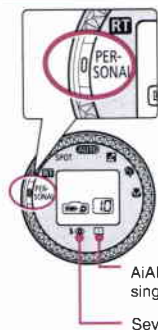

- 1 Set the dial to **PERSONAL** and set the Flash and AF modes. (See p. 34 and p. 41 for details on the functions that can be set and how to set them.)

AiAF with three-point metering/
single-point central AF (→ 41)

Seven flash modes (→ 34)

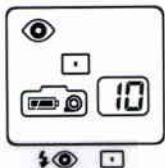



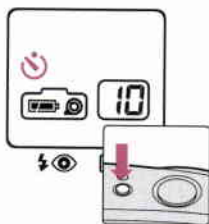

- 2 When you turn the dial, the functions you specified in step 1 are stored in memory. Subsequently, you can take pictures using those functions simply by setting the dial to **PERSONAL**.

Using the Self-timer

The self-timer function allows you to take a picture when you are some distance from the camera.



1 Set the camera to self-timer mode.

- Press the  button.
- ➔  appears on the LCD panel.
- If you then press the  button again,  disappears and self-timer mode is cancelled.

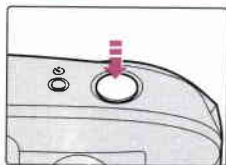

2 Compose the picture and press the shutter button.

- ➔ The red-eye reduction lamp blinks once a second and a countdown of the number of seconds remaining before the photo is taken is displayed on the LCD panel.
- ➔ The shutter is released approximately 10 seconds later.
- To cancel the self-timer, press the .



Do not stand directly in front of the camera when you press the shutter button as this will result in the picture being out of focus.



- Approximately 2 seconds before the shutter is released, the lamp begins to flash more rapidly. If the flash and the red-eye reduction function are used, the lamp stays lit for the last 2 seconds.
- Self-timer shots can be taken for the 4 minutes that  is displayed.
- Set the camera on a steady surface or use a tripod.
- The focus lock function can be used in the same way as in normal photography. (→ 42)

Remote Control Photography **CAPTION**

E

You can use the remote control to release the shutter from up to 5 m /16.4 ft. in front of the camera.

Remote Control (RC-5)

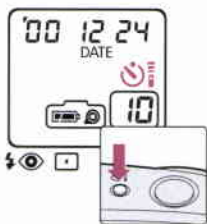
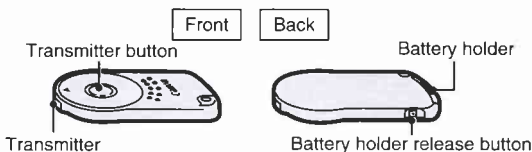

1 Set the camera to remote control mode.

- Press the button.
- ➔ appears on the LCD panel.
- If you then press the button again, disappears and remote control mode is cancelled.

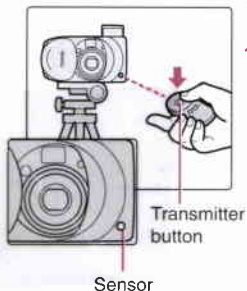

2 Take the picture.

- Lock the focus (→ 42) and then compose your shot. Then point the remote control towards the sensor on the camera and press the transmitter button.
- ➔ The red-eye reduction lamp blinks once a second (or remains lit when red-eye reduction is used) and a countdown is displayed on the LCD panel to show that the camera has received the signal from the remote control.
- ➔ The shutter is released approximately 2 seconds later.

Replacing the Remote Control Battery

Replace the battery when you can no longer use the remote control to take photos.

Battery: one CR2032 3V lithium battery

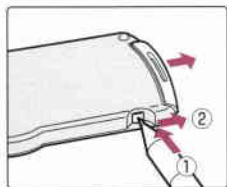

1 Pull out the battery holder.

- Use a pen or other pointed implement to push in the release button ① as you slide the battery holder out ②.

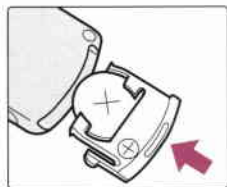

2 Load a new battery into the holder and fit the holder back into the remote control.

- Ensure that the + and – terminals are positioned correctly.



- Remote control photography may not be possible if the remote control sensor on the camera is exposed to sunlight or strong fluorescent light. In such situations, use the self-timer to take the picture, or move the camera to another location.
- The camera's remote control function may not operate correctly if the camera is close to a fluorescent light during signal reception. If this occurs, move the camera away from the fluorescent light.



- Remote control shots can be taken for the 4 minutes that  is displayed.
- Set the camera on a steady surface or use a tripod.
- The focus lock function can be used in the same way as in normal photography. (→ 42)

Imprinting the Date and Time **CAPTION**

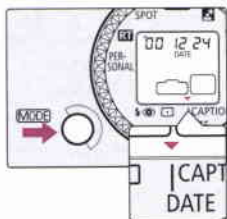

E

You can imprint the date and time the picture was taken in the lower right corner of the photograph.



- 1** Select the Date mode.
- Press the **MODE** button until ▼ appears above DATE.



- 2** Select the date and time combination.
- The date and time combination changes each time you press the **SET** ( or ) button.
 - When you have selected the desired date mode, press the **MODE** button to return the camera to the normal state. (→ 33)
 - Take the picture.

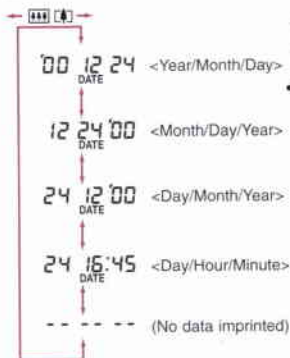

Date/time imprinted here.

4

The "00" in the year display indicates the last two digits in the year 2000.

Setting the Date and Time **CAPTION**

When you replace the battery or travel abroad, use the procedure below to set or adjust the date and time settings.

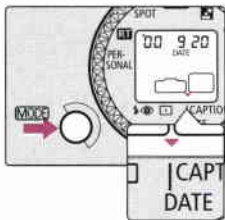

- 1 Select Date mode.**
- Press the **MODE** button until ▼ appears above **DATE**.

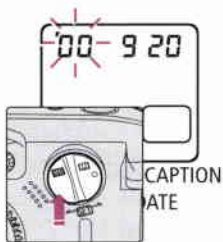

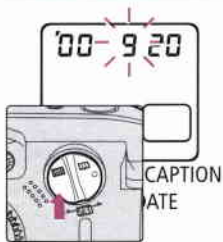

- 2 Select the Date and Time Setting mode.**
- Press the **AAA** button for more than 2 seconds.



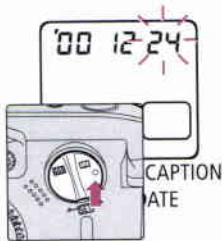

- 3 Select the date and time you want to set.**
- Press the **AAA** button to select the setting.
 - ➔ The selected setting changes sequentially from year to month to date to hour to minute.



4 Set the date and time.

- Press the  button to set the date.
- Repeat steps 3 and 4 to set all the date and time settings.
- If you press the  button and none of the date settings blink, date setting is complete.



- Each time you replace the battery, the date display on the LCD panel reverts to "-- -- --". When this occurs, set the date and time.
- Each time the  button is pressed, the number increases by one. If kept pressed, the number increases quickly.
- If you press the  button when ":" is blinking, the seconds display is set to zero.
- If you do not perform any operation for about 10 seconds, the ▼ indicator goes off, and normal state is automatically entered. In that case, correctly reperform the operations from step 1.

Imprinting Captions **CAPTION**

Selecting the Caption

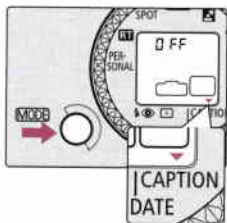

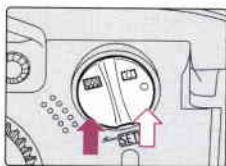

1 Select Caption mode.

- Press the **MODE** button until ▼ appears above **CAPTION**.



2 Select a caption.

- The caption number changes each time you press the **SET** ( or ) button.
- Select **OFF** to cancel the caption.
- When you have selected the desired caption mode, press the **MODE** button to return the camera to the normal state. (→ 33)

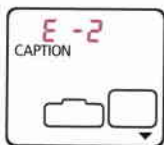

English captions



Selecting the Language

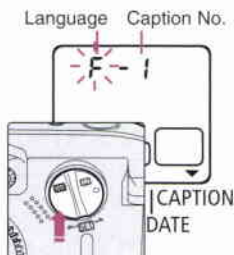

1 Select the Switch Language mode.

- Press the **[SET]** button for more than 2 seconds.
- ➔ LANGUAGE blinks.
- ➔ The caption number reverts to No. 1 for each language.

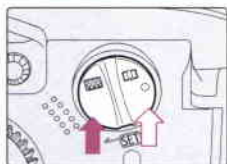

2 Select the language.

- Each time the **[L]** button is pressed, the language changes sequentially from E (English) to F (French) to D (German) to ES (Spanish).
- Press the **[SET]** button to make your selection.



Use 12, 24 or 36-exposure film that bears the DX marking. If you use film with other numbers of exposures, it may not be possible to imprint the date or caption on the final shots.



- To imprint a caption only, set the date display to "-- -- --" (→ 47) and then select the caption.
- The caption is cleared after each photo is taken. To imprint the caption in successive photos, press the **[L]** button for more than 2 seconds. CAPTION, on the LCD panel, blinks.

When this occurs, the caption number reverts to No. 1 for each language so press the **SET** (**[SET]** or **[L]**) button to select the desired caption number.

French captions

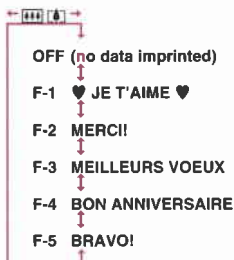

Spanish captions

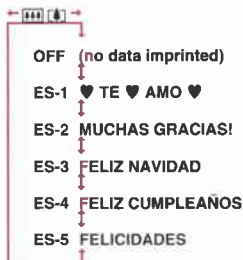

German captions





When you select the Switch Language mode, the caption number reverts to No. 1 for each language. When you select the language in step 2, press the **SET** () or () button and select the desired caption number again.

Troubleshooting

E

In case of problems, check the table below before taking your camera to be repaired.

Problem	Cause	Remedy	Page
The  blinks on the LCD panel.	<ul style="list-style-type: none">• The battery has run out of charge.	<ul style="list-style-type: none">• Replace the battery.	13
The  is not displayed on the LCD panel.	<ul style="list-style-type: none">• No battery is loaded.	<ul style="list-style-type: none">• Install the battery.	13
	<ul style="list-style-type: none">• The battery is installed with the wrong polarities.	<ul style="list-style-type: none">• Reinsert the battery correctly.	13
	<ul style="list-style-type: none">• The battery has completely run out of charge.	<ul style="list-style-type: none">• Replace the battery.	13
The shutter does not release.	<ul style="list-style-type: none">• The power is turned off.	<ul style="list-style-type: none">• Turn the power on.	16
	<ul style="list-style-type: none">• The battery has run out of charge.	<ul style="list-style-type: none">• Replace the battery.	13
	<ul style="list-style-type: none">• The film is not loaded correctly.	<ul style="list-style-type: none">• Load a new film.	14
	<ul style="list-style-type: none">• A rewind (used) film has been loaded.	<ul style="list-style-type: none">• Remove the film and load a new one.	14, 24
	<ul style="list-style-type: none">• The shutter releases only after the red-eye reduction lamp is lit for about 1 second.	<ul style="list-style-type: none">• Hold the shutter button down until the shutter releases.	26
			<ul style="list-style-type: none">• Change the flash mode.
The camera makes a zooming sound when I press the shutter button down halfway.	<ul style="list-style-type: none">• Realtime Release mode has been set.	<ul style="list-style-type: none">• Set the dial to a setting other than .	10

Problem	Cause	Remedy	Page
The photographs are blurred.	<ul style="list-style-type: none"> •The AF emitter/sensor was obscured when the shutter was released. 	<ul style="list-style-type: none"> •Ensure that the AF emitter/sensor is not obscured by your hair, fingers etc. 	18
	<ul style="list-style-type: none"> •In \odot mode, you were standing directly in front of the camera when you pressed the shutter button. 	<ul style="list-style-type: none"> •Make sure that you do not stand directly in front of the camera when pressing the shutter button. 	44
	<ul style="list-style-type: none"> •The camera moved when you pressed the shutter button (camera shake). •The AF emitter/sensor or lens is dirty. 	<ul style="list-style-type: none"> •Press the shutter button slowly and gently. •Wipe them clean. 	18
"H" is displayed on the LCD panel.	<ul style="list-style-type: none"> •The self-diagnosis function detected an error. 	<ul style="list-style-type: none"> •Remove the battery from the camera. When the "H" disappears from the LCD panel, load the battery again. 	13
The flash does not fire.	<ul style="list-style-type: none"> •The flash is pushed back into the camera. 	<ul style="list-style-type: none"> •Ensure that you do not press on the flash. 	16

Questions and Answers

E

Q1 Can slide (reversal) film be used?

A1 Yes it can.

The following film speed slide films attached with a DX code can be used: ISO 25, 50, 100, 200, 400, 800, 1600, 3200

Q2 What is the film speed (ISO number)?

A2 The ISO number indicates the film's sensitivity to light in numerical terms. The higher the number, the more sensitive the film is to light. Film with an ISO number of 400 should be used for normal photography.

Q3 Can film that does not have the DX marking be used?

A3 Yes, it can. However, when film with no DX code is loaded, the film speed is set to ISO 25. After loading film with no DX marking or a speed of ISO 25 into the camera, close the back cover and press the shutter button once or twice.

CAPTION

Q4 The date imprinted on my photos is difficult to see.

A4 Perhaps the background where the date is imprinted is very bright. Try to ensure that there is a dark object where the date will appear. Similarly, avoid having yellowish or white objects where the date will be imprinted.

5

Specifications

Type: Fully-automatic 35 mm lens-shutter AF camera with built-in zoom lens

Image Size: 24 × 36 mm

Lens: Canon 28–90 mm f/4.5–9.9 lens

Focusing: Active/passive hybrid AiAF

Focal Distance: Normal: 0.6 m/2.0 ft. to ∞

Close-up: 0.45 m/1.5 ft. to ∞ (90 mm fixed)

Shutter: Combination aperture and program electromagnetically driven shutter

Viewfinder: Real-image zoom viewfinder

Coverage: Approx. 84%

Eyesight Adjustment: –3 to 0 dpt

Viewfinder Information: Picture frame, AF frame, Close-up frame

Viewfinder Eyepiece:

Green indicator: Combination camera ready indicator and proximity warning

Orange indicator: Combination flash ready indicator and camera shake warning

Film Loading: Automatic

Film Advance: Fully automatic with mid-roll rewind possible

Frame Counter: Counts up during film advance and counts down during film rewinding

Self-timer: 10 sec. delayed shutter release timer with operation displayed on the LCD panel

Exposure Control Range:

AUTO and Flash ON modes:

Wide-angle: 1/640 sec. at f/14.2 to 1/50 sec. at f/4.5

Telephoto: 1/350 sec. at f/30 to 1/87 sec. at f/9.9



Flash OFF and Slow-synchro modes (up to 4 sec. for night mode):

Wide-angle: 1/640 sec. at f/14.2 to 2 sec. at f/4.5

Telephoto: 1/350 sec. at f/30 to 2 sec. at f/9.9

Exposure Compensation: Automatic exposure compensation and ±1.5-step manual exposure compensation

Best Shot Function Table

Mode	AF		Light metering		Backlight detection
	AiAF	Single-point AF	3-zone	Spot	
AUTO	●	○	●		●
	●	○	●		●
		●	●		●
		●	●		●
RT	●	○	●		●
SPOT		●		●	
PERSONAL	●	○	●		●

Film Speeds: ISO 25–3200, set automatically in 1-step increments using DX codes

Built-in Flash: Internal zoom flash fires automatically in low light and backlit conditions

[ISO 100] Wide-angle: 0.6 to 3.7 m/2 to 12.1 ft.
Telephoto: 0.6 to 2.3 m/2 to 7.5 ft.

[ISO 400] Wide-angle: 0.6 to 7.4 m/2 to 24.3 ft.
Telephoto: 0.6 to 4.6 m/2 to 15.1 ft.

(using color negative film)

Flash Recycling Time: Approx. 5 seconds (with new battery)

Switch Flash Modes: Set Flash mode and press the zoom button.

Power Supply: One CR123A/DL123A lithium battery

Number of Shots: Approx. 14 rolls of 24-exposure film (normal temperature with 50% flash use)

Dimensions (W × H × D): 117 × 64 × 43 mm/4.6 × 2.5 × 1.7 in.

Weight: Models without captions: 245 g/8.6 oz. (excluding battery and film)

Models with captions: 250 g/8.8 oz. (excluding battery and film)

CAPTION

Automatic Date: Automatic built-in calendar (programmed up to 2029 with automatic correction for leap years)

Imprinted data: Date: 5 formats (including no imprinting)
Captions: 5 captions in 4 languages

Character Types: 6 × 7 dot matrix

Imprinting Color: Orange

Remote Control: Remote control photography within approx. 5 m/16.4 ft. using the RC-5 Remote Control (sold separately). Two-second shutter release delay. RC-5 shutter release capacity of approx. 6000 shots.

- All data are based on Canon's Standard Test Method.
- Subject to change without notice

○: User-selectable

PER. SIGNAL : Factory settings shown

Automatic exposure compensation	Fixed magnification	Minimum distance (m/ft.)	Default flash setting	
			Flash	Red-eye reduction
●		0.6/2	AUTO	○
●		0.6/2	SS*	●
●	●	0.6/2	ON	●
●		0.45/1.5	AUTO	○
●		0.6/2	AUTO	○
●		0.6/2	AUTO	○
●		0.6/2	AUTO	○

*SS: Slow-synchro mode

MEMO

A series of horizontal dashed lines for writing.

Canon

CANON INC. 30-2, Shimomaruko 3-chome, Ohta-ku, Tokyo 146-8501, Japan

U.S.A. ——— CANON U.S.A. INC.

For all inquiries concerning this camera, call toll free in the U.S.
1-800-828-4040 or write to: Customer Relations, Canon U.S.A., Inc.
One Canon Plaza, Lake Success, N.Y. 11042-1198

CANADA ——— CANON CANADA INC. HEADQUARTERS

6390 Dixie Road, Mississauga, Ontario L5T 1P7, Canada

CANON CANADA INC. MONTREAL BRANCH

5990, Côte-de-Liesse, Montréal Québec H4T 1V7, Canada

CANON CANADA INC. CALGARY OFFICE

2828, 16th Street, N.E. Calgary, Alberta T2E 7K7, Canada

For all inquiries concerning this camera, call toll free in Canada
1-800-828-4040

EUROPE, ——— CANON EUROPA N.V.

AFRICA & MIDDLE EAST Bovenkerkerweg 59-61, P.O. Box 2262, 1180 EG Amstelveen,
The Netherlands

CANON PHOTO VIDEO FRANCE S.A. Service Center

102, Avenue du Général de Gaulle 92257 La Garenne-Colombes Cedex, France

CANON UK LTD.

Woodhatch Reigate Surrey RH2 8BF, United Kingdom

CANON EURO-PHOTO G. m. b. H.

Siemensring 90-92, D-47877 Willich, Germany

CANON ITALIA S.p.A.

Palazzo L, Strada 6, 20089 Rozzano, Milanofiori, Milano, Italy

CANON Benelux N.V./S.A.

Bessenveldstraat 7, 1831 Diegem (Machelen), Belgium

CANON Schweiz AG

Geschäftsbereich Wiederverkauf, Industriestrasse 12, CH-8305 Dietlikon,
Switzerland

CANON G. m. b. H.

Oberlaaerstrasse 233, 4th floor, 1100 Wien, Austria

CANON España, S. A.

C/Joaquín Costa, 41, 28002 Madrid, Spain

SEQUE Soc. Nac. de Equip., Lda.,

Praça da Alegria, 58, 2º, 1269-149 Lisboa, Portugal

CENTRAL & ——— CANON LATIN AMERICA, INC. DEPTO DE VENTAS

SOUTH AMERICA 6505 Blue Lagoon Drive, Suite 325, Miami, FL33126 U.S.A.

CANON LATIN AMERICA, INC. CENTRO DE SERVICIO Y REPARACION

Apartado 2019, Zona Libre de Colón, República de Panamá

ASIA ——— CANON HONGKONG CO., LTD.

9/F, The Hong Kong Club Building, 3A Chater Road, Central, Hong Kong

OCEANIA ——— CANON AUSTRALIA PTY. LTD.

1 Thomas Holt Drive, North Ryde, N.S.W. 2113, Australia

CANON NEW ZEALAND LTD.

Fred Thomas Drive, P.O. Box 33-336, Takapuna, Auckland, New Zealand

JAPAN ——— CANON SALES CO., INC.

12-15 Mita, 3-Chome, Minato-ku, Tokyo 108-8011, Japan